



TRANSMITTER
CSA-524

INSTRUCTION MANUAL

MINEBEA CO., LTD

Measuring Components Business Unit

EN294-1301

Forwards

Thank you very much for your purchasing Minebea's Transmitter CSA-521.

This manual explains installation procedures and connecting method and also operating method for the Transmitter CSA-521. Make use of it properly after reading through the manual carefully.

Moreover, the end user should keep the manual at hand.

Marks and arrangements used in this manual

The following marks are attached to the explanation on the matters that indicate "Don't do this.", "Take care." and "For reference".

Be sure to read these items where these marks are attached.

 **Warning**

Warning may cause injury or accident to the operator, even death might occur.
Never do these things described here.

 **Notice**

Injury or harm that might occur to the operator during maloperation is made, or occurrence of physical harm, such as physical harm.



Caution during operation and working.
Be sure to read the item to prevent malfunction.

For safe operation

Be sure to read these sentences before use.

1. Installation place



Notice

Use the instrument where the temperature/humidity specifies with the range as follows :

- Environmental temperature: $-10\text{ }^{\circ}\text{C}$ to $50\text{ }^{\circ}\text{C}$
- Environmental humidity : Less than 85 %RH (Non condensing.)



Warning

Don't locate the instrument on the places as follows:

It may cause an unexpected faulty in the instrument.

① Location where installation is not allowed.

- Don't locate the instrument in direct and/or high temperature area.
- Don't use the instrument in a high humid area.
- Don't install the instrument where there are vibrations and shocks.
- Don't use the instrument where there is excess of dusts and fine particles.
- Don't use the instrument where there are corrosive gas and salt and like that.
- Don't install the instrument where there is rapid change of temperature and humidity.
- Don't install the instrument near the devices that are magnetized or generate an electromagnetic field.
- Don't install the instrument where the instrument may be affected by radioactivity or radial rays.
- Avoid the location where chemical reaction may take place such as in a laboratory, or like that.

② Installation

Warning

When installing the instrument, install as referring to the following figures and secure the space around the instrument.

Each dimensions of the instrument and required dimensions for the environmental spaces are as follows:

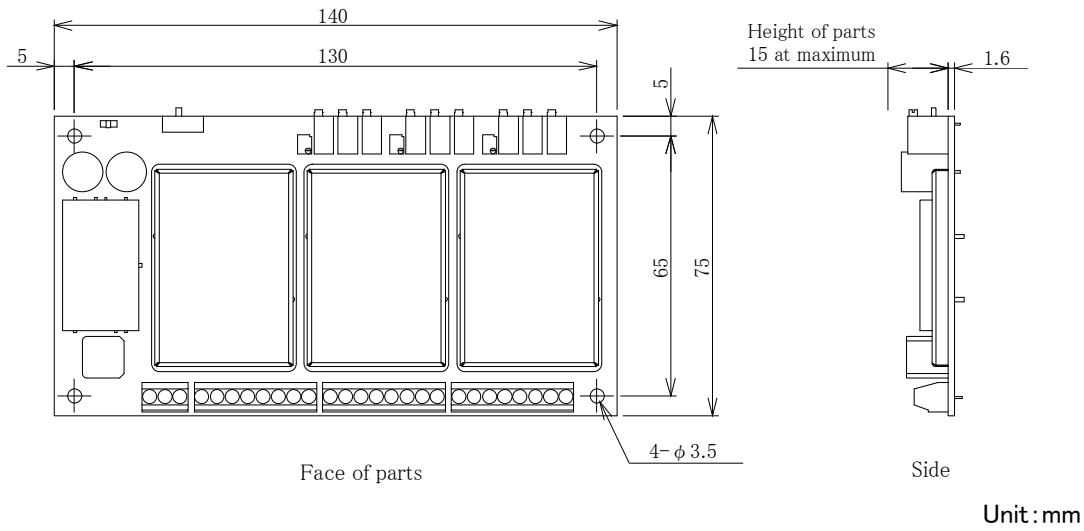

1. Power supply

Warning

Be sure to check that the power supply is off in connecting each cable. If the work is done while the power is on, there may have the case that electric shock to the operator or even may have damage to the instrument.

Warning

Before supplying the power, check that the indication of power supply voltage and its specifications for the instrument and the power going to supply should be the same.

If they are not equal, contact with Minebea.

If you use the instrument without checking it, that may cause a damage in the instrument or electric shock to the operator.

Notice

An earth wire should be grounded securely.

When an earth wire is not connected, it may cause a malfunction of the instrument or electric shock to the operator.

2. Application note

Notice

Before using a new instrument or exchanging the strain gage applied transducer for a new one, be sure to make calibration. If calibration will not be made, the correct measuring results may not be obtained nor which may cause malfunction in the instrument and there may exist damage in peripheral equipments.

Even though calibration has been made, there may occur the similar case when the results are not correct, so make calibration again.

Notice

In case of using the instrument, check that the connections are executed properly. If not connected properly, the correct measured result will not be obtained, nor may it cause malfunctions of the instrument, damage to the peripheral equipments or even more serious accidents.

Notice

When change of setting is made carelessly on the instrument during measurement, correct measured results may not be obtained and it may cause malfunction in the instrument and even have the possibility of damage in peripheral instruments.

Notice

Do not shock the instrument such as throwing something on it.

If neglected, it may cause destruction of the parts and damage to the electrical circuits.

Record of revision

Date	Instruction manual No.	Revised reasons (contents)
2008/10	DRW. NO.EN294-1301	First revision

CONTENTS

FORWARDS	I
FOR SAFE OPERATION	II
1. INSTALLATION PLACE	II
1. POWER SUPPLY.....	IV
2. APPLICATION NOTE.....	IV
RECORD OF REVISION	V
1. EACH NAME AND FUNCTION	1
2. CONNECTION	3
2-1. A LAYOUT OF TERMINAL BOARD.....	3
2-2. NOTES RELATED WITH CONNECTION.....	4
2-3. CONNECTION WITH THE STRAIN GAGE APPLIED VECTOR SENSOR CONNECTION WITH THE STRAIN GAGE APPLIED VECTOR SENSOR.....	4
2-4. CONNECTION WITH POWER SUPPLY AND THE EARTH.....	5
2-5. CONNECTION WITH ANALOG OUTPUT.....	6
3. CALIBRATION	7
3-1. CALIBRATION METHOD.....	7
3-2. CALIBRATION PROCEDURES.....	8
4. FUNCTION AND OPERATION	11
4-1. RANGE OF ZERO ADJUSTMENT.....	11
4-2. RANGE OF GAIN ADJUSTMENT.....	11
4-3. CALIB VALUE.....	11
4-4. RESPONSE FREQUENCY.....	11
4-5. BRIDGE POWER SUPPLY VOLTAGE.....	11
5. TROUBLE-SHOOTING	12
6. SPECIFICATIONS	18
6-1. SPECIFICATIONS.....	18
6-2. GENERAL SPECIFICATIONS.....	18
6-3. ACCESSORIES.....	18
6-4. SPECIFICATIONS FOR STANDARD SHIPMENT.....	18
7. WARRANTY	19
7-1. WARRANTY.....	19
7-2. REPAIR.....	19

1. Each name and function

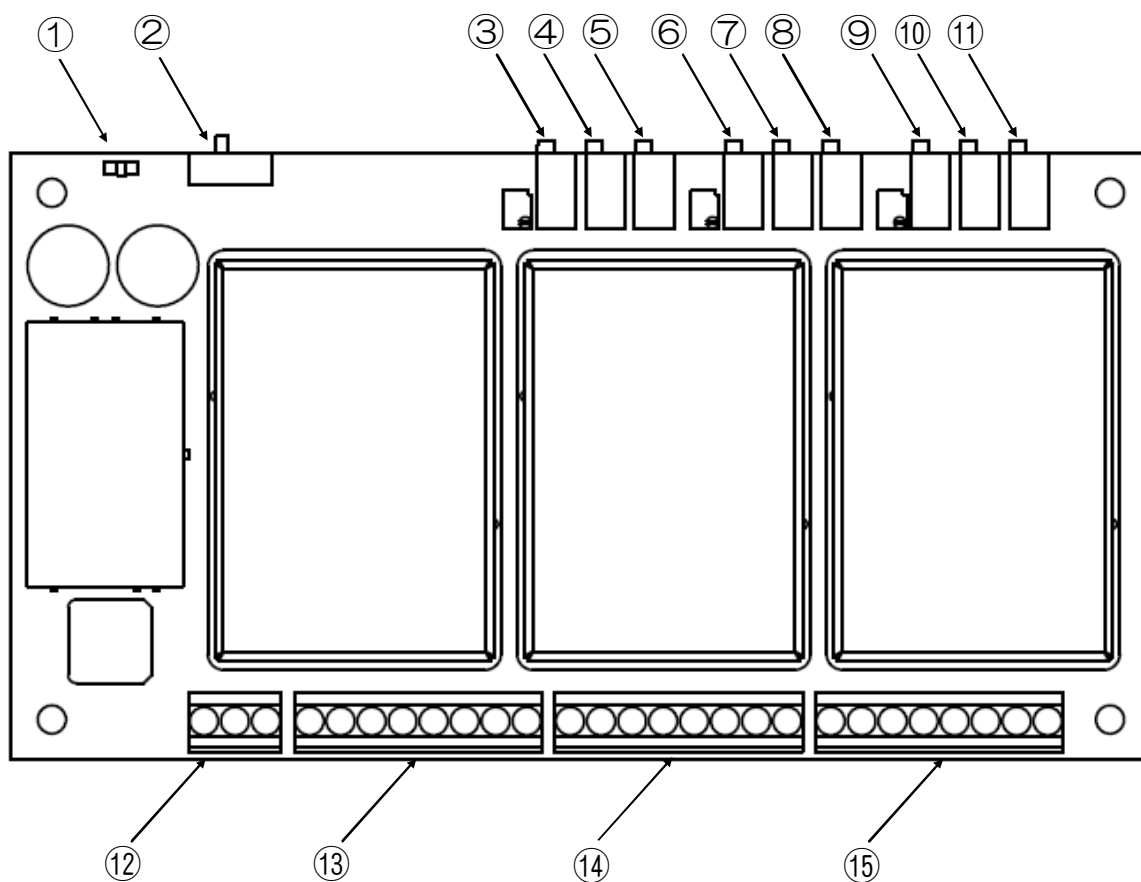

① POWER LED

Lights up with the power ON.

② CALIB SW

Outputs the calibration value of Fx, Fy and Fz.

③ GAIN adjustment trimmer for Fx axis

The trimmer for adjusting amplification degree of Fx axis.

④ ZERO fine adjustment trimmer for Fx axis

The trimmer for fine adjustment on zero point of Fx axis.

⑤ ZERO coarse adjustment trimmer for Fx axis

The trimmer for coarse adjustment on zero point of Fx axis.

⑥ GAIN adjustment trimmer for Fy axis

The adjustment trimmer for amplification degree of Fy axis.

⑦ ZERO fine adjustment trimmer for Fy axis

The trimmer for fine adjustment on zero point of Fy axis.

⑧ ZERO coarse adjustment trimmer for Fy axis

The trimmer for coarse adjustment on zero point of Fy axis.

⑨ GAIN adjustment trimmer for Fz axis

The trimmer for adjustment of amplification degree of Fz axis.

⑩ ZERO fine adjustment trimmer for Fz axis

The trimmer for fine adjustment on zero point of Fz axis.

⑪ ZERO coarse adjustment trimmer for Fz axis

The trimmer for coarse adjustment on zero point of Fz axis.

⑫ Terminal board for power supply

Make connection with DC power supply and a grounding wire.

⑬ Terminal board for connection with Fx axis

Makes connection with the Fx axis of strain gage applied vector sensor and also connects with the analog out put of Fx axis.

⑭ Terminal board for connection with Fy axis

Makes connection with the Fy axis of strain gage applied vector and also connects with the analog output of Fy axis.

⑮ Terminal board for the connection with Fz axis

Makes connection with the Fz axis of strain gage applied vector and also connects with the analog output of Fz axis.

2. Connection

2-1 .A Layout of terminal board

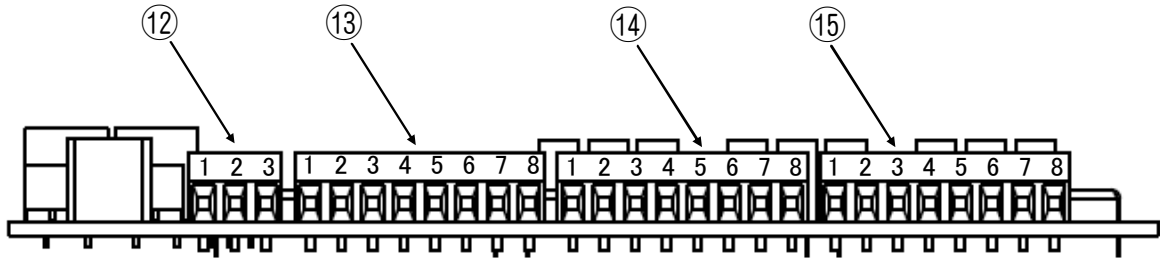

Terminal board	Name of terminal board	Description	Application
⑫	1	DC power supply (+)	Supply power source
	2	DC power supply (-)	
	3	F.G.	
⑬	1	Fx axis bridge power supply (+)	A vector sensor applied vector sensor Connection with Fx axis
	2	Fx axis bridge power supply (-)	
	3	N.C.	
	4	Amplifier input for Fx axis (-)	
	5	GND	Analog output for Fx axis
	6	GND	
	7	Voltage output terminal for Fx axis (+)	
	8	Voltage output terminal for Fx axis (-)	
⑭	1	Bridge power supply for Fy axis(+)	Strain gage applied vector sensor Connection with the Fy axis
	2	Bridge power supply for Fy axis (-)	
	3	N.C.	
	4	Amplifier input for Fy axis (-)	
	5	GND	Analog output for the Fy axis
	6	GND	
	7	Voltage output terminal for the Fy axis(+)	
	8	Voltage output terminal for the Fy axis(-)	
⑮	1	Bridge power supply for the Fz axis (+)	Strain gage applied vector sensor Connection with the Fz axis
	2	Bridge power supply for the Fz axis (-)	
	3	Amplifier input for the Fz axis (+)	
	4	Amplifier input for the Fz axis (-)	
	5	GND	Analog output for the Fz axis
	6	GND	
	7	Voltage output terminal for the Fz axis (+)	
	8	Voltage output terminal for the Fz axis (-)	



- The terminal of voltage output (-) and the terminal of DC power source (-) are isolated.
- The GND terminal and the DC power supply terminal (-) are isolated.
- The GND terminal and the voltage output (-) terminal are connected internally.

2-2. Notes related with connection

- When connecting, be sure to make it with the power supply OFF.
- Never turn on electricity until the installation has completed.
- Separate the cable to connect with the instrument from the noise sources such as power supply lines and/or I/O lines for control as much as possible.
- Use the exclusive conduit wiring for this instrument, and avoid using with another line together.
- Be sure to connect with the grounding wire. The grounding should be the D class single earth. Never use with the grounding of power supply line together.
- The suitable ranges of wires for the terminal board for the instrument are as follow:
 - Sizes of electric wire : 0.14 mm² to 1.5 mm² (AWG26 to AWG16) stranded wire
 - The length of electric wire peeled away : 5 mm ± 1mm
- Recommended torque to tighten the terminal screws for terminal board is as follows:
 - Claming torque : 0.22N · m to 0.25N · m

2-3. Connection with a strain gage applied vector sensor

Connection with a strain gage applied vector sensor

You can connect the instrument with the strain gage applied vector sensor.

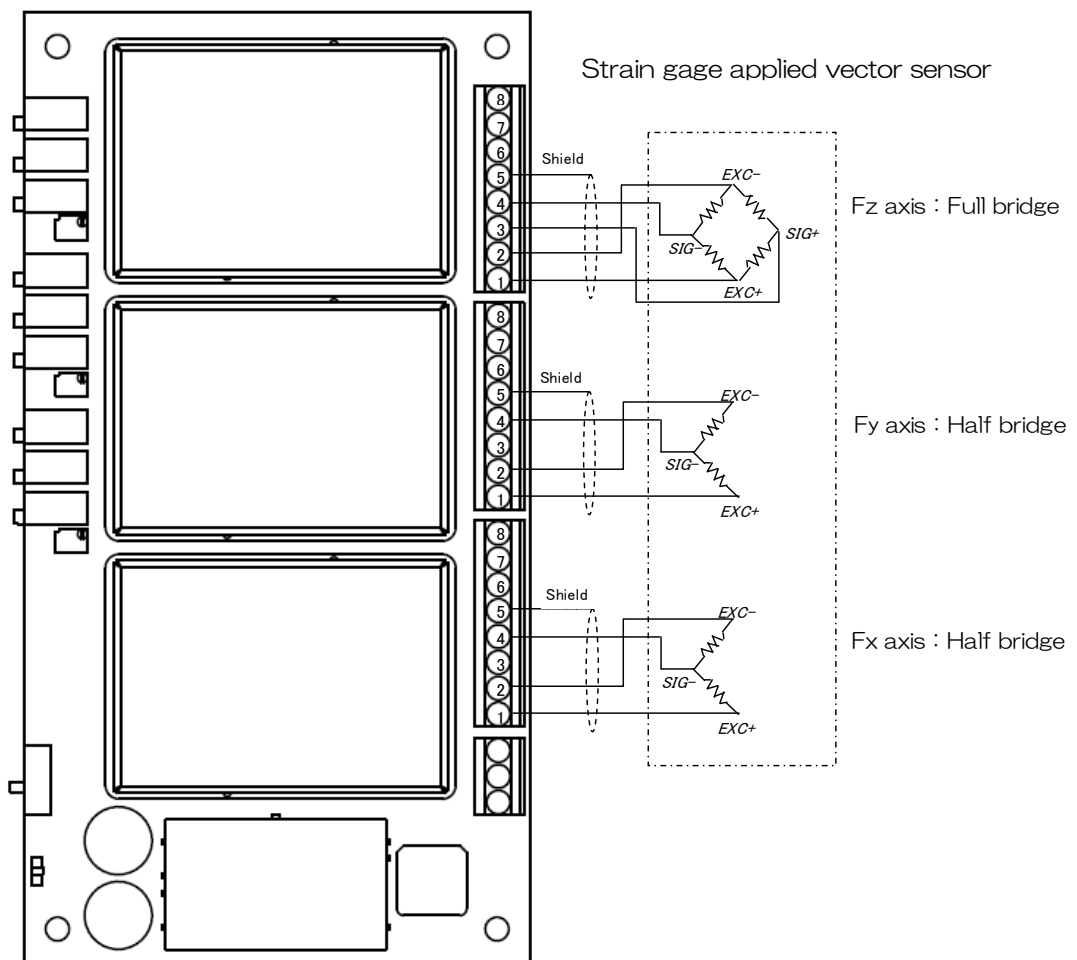

- When the cable length is more than 10 m totally, there may have the case that the accuracy is out of warranty, because the resistance of cable makes the supply voltage to the strain gage applied transducer decreased.
- When the cable length is more than 10 m, the CALIB value becomes out of application.

2-4. Connection with power supply and the earth

Connections with the power supply and the earth should be made as follows:

Grounding should be the D class with single earth.

Power supply voltage	DC24 V (Allowable variable range: DC18 V to DC36 V)
Current consumption	Approx: 100 mA

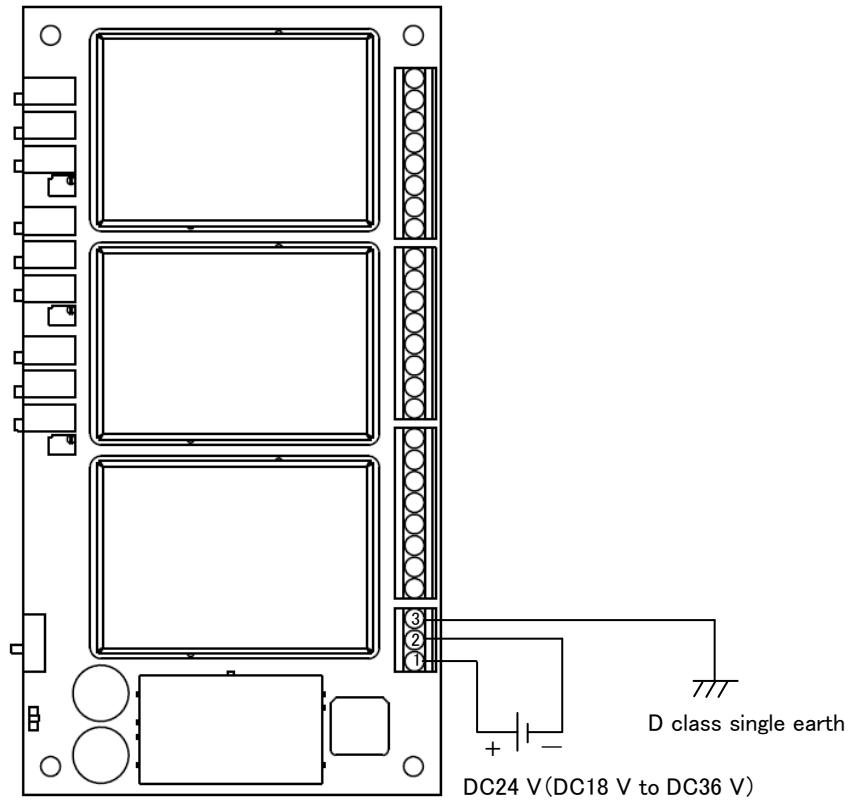

Notice

- Connections with the power supply and the earth should be made securely according to the figures and also within the rated capacity of the instrument.



- Grounding should be the D class with single earth. If neglected, it may cause an unexpected malfunction due to the effects of external noise from other equipments.

2-5.Connection with analog output

The connections with voltage output shall be made as the following figure.

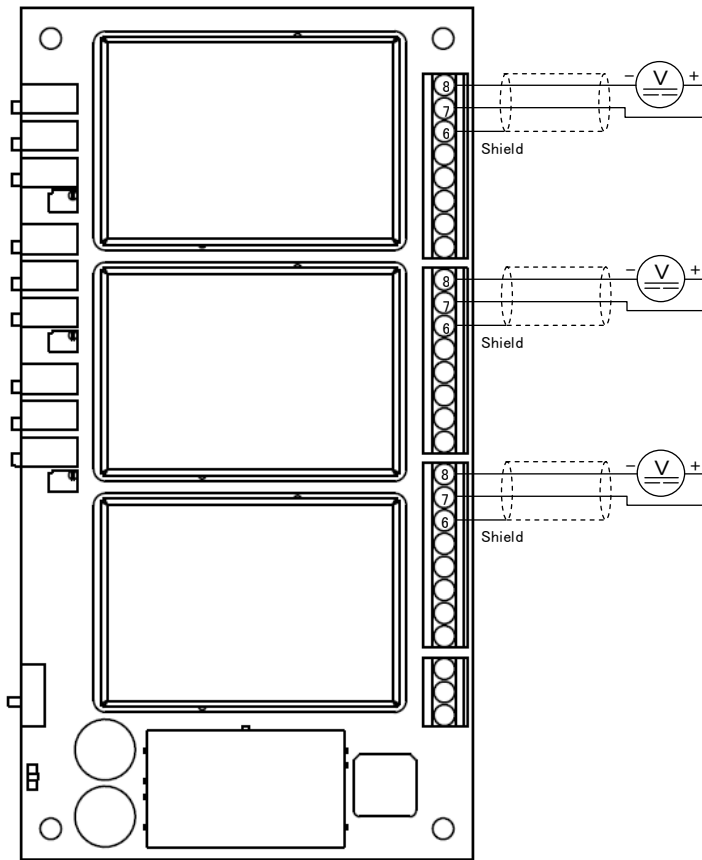

Fz voltage output

- DC0 V to DC ± 5 V
- Load resistance is more than 2k Ω .

Fy voltage output

- DC0 V to DC ± 5 V
- Load resistance is more than 2k Ω .

Fx voltage output

- DC0 V to DC ± 5 V
- Load resistance is more than 2k Ω .



- Be sure to connect with a shielded cable for the analog output, and the shield wire should be connected with the GND terminal. If not connected, there may have the possibility of malfunction due to the effect of external noises.

3. Calibration

3-1 .Calibration method

Load calibration methods for the instrument are two as follows:

- ① Calibration with the actual load
- ② Calibration with CALIB inputs



Notice

- Before using a new instrument or after exchanging the strain gage applied vector sensor with a new one, be sure to make calibration. If calibration is not made, correct measured results may not be obtained, or it may cause malfunction to the instrument and it may damage the peripheral equipment. Moreover, even if calibration has made, there may occur the similar case as above when the result is not correct. So make precise calibration again.
- Make calibration with the CALIB SW to OFF position.



- The accuracy of calibration with CALIB input is 1/500 or so.

3-2. Calibration procedures

3-2-1. Calibration with actual load

Step 1 Connection with a strain gage applied vector sensor

Connect the instrument with a strain gage applied vector sensor.

Step 2 After feeding power, turn on electricity for 20 minutes.

To stabilize the instrument and a strain gage applied vector sensor, turn on electricity for about 20 minutes.

Step 3 ZERO adjustment

Make the condition that initial load (tare weight) is applied on the strain gage applied vector sensor.

Cancel the initial load (tare weight) with ZERO coarse adjustment trimmer and ZERO fine adjustment trimmer for each Fx axis, Fy axis and Fz axis.

With the ZERO coarse adjustment trimmer, you can make adjustment of input portions of approx. $\pm 3\ 000\ \mu\text{st}$ in input conversion.

With the ZERO fine adjustment trimmer, you can make adjustment of input portions of approx. $\pm 300\ \mu\text{st}$ in input conversion.

Make fine adjustment so that the voltage output value shall become 0.000 V for each axis.

Step 4 SPAN adjustment

Load standard weights (use them as near as the standard weights) on whichever one axis in Fx axis, Fy axis and Fz axis, then adjust with the GAIN trimmer for the corresponding axis so that the voltage output value to be set shall be obtained.

With the GAIN trimmer, you can change the range of full scale of 1/1 to 1/2. You can adjust in the same way for another axes.

Step 5 Check on ZERO point

Remove the standard weights applied in the step 4, and check that the voltage output value shall be 0.000 V.

If not obtained, return to the step 3.

Step 6 End of calibration

The calibration due to actual loads shall be completed.

3-2-2. Calibration with input of CALIB

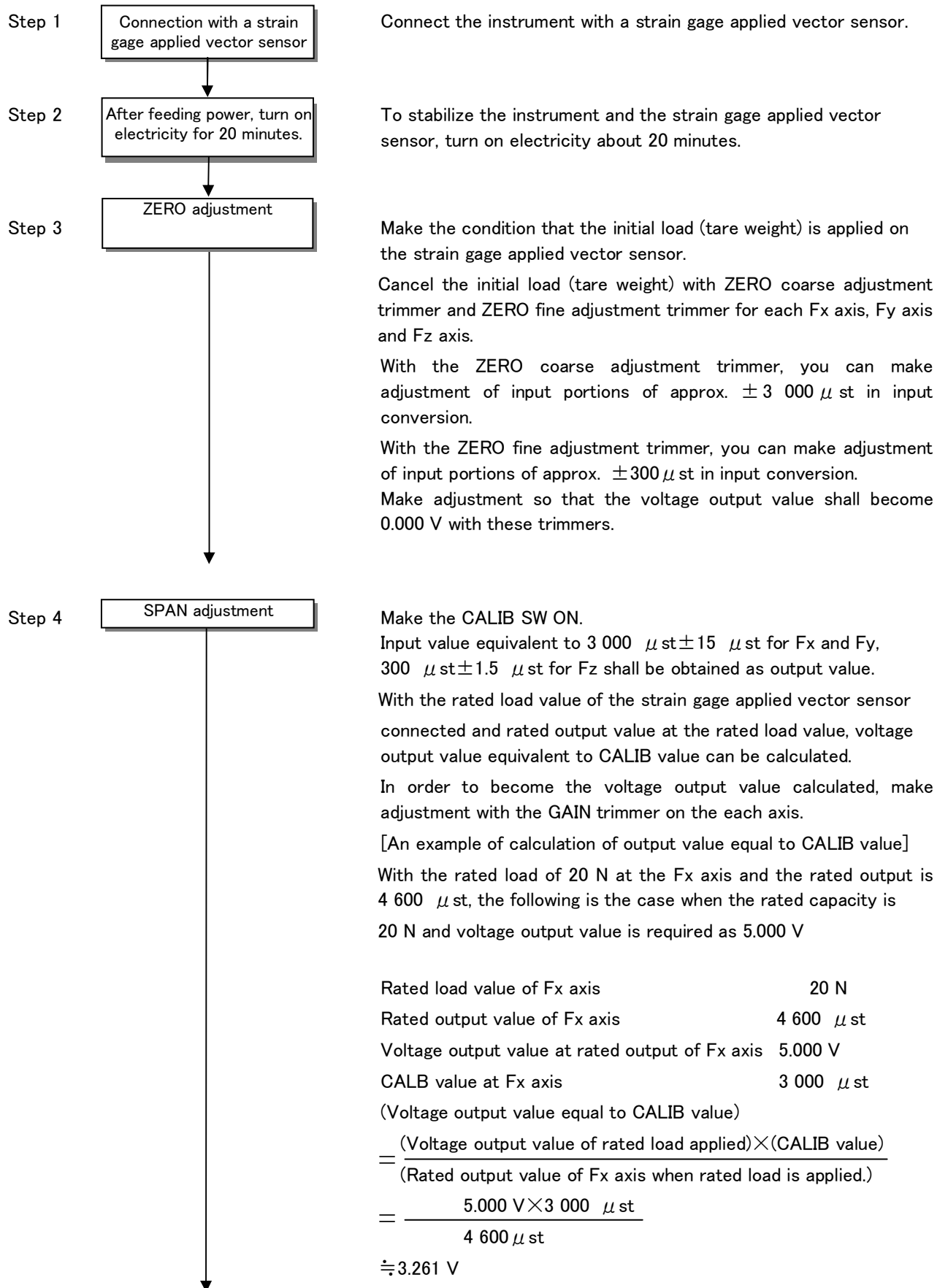

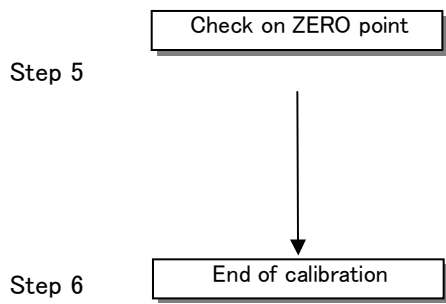

In due course, the voltage output value during the CALIB SW ON can be adjusted to 3.261 V with the GAIN adjustment trimmer. Press on the CALIB SW. Check that the voltage output value becomes 0.000 V. If not, return to the step 3.

Now, calibration has completed with input of CALIB.

 **Notice**

- The rated output value applied to the calculation should be the value that has written on the Test Report individually.

4. Function and operation

4-1. Range of ZERO adjustment

With the ZERO coarse adjustment trimmer and the ZERO fine adjustment trimmer, the zero point can be varied.

Axis	Variable ranges with ZERO coarse adjustment trimmer	Variable ranges with ZERO fine adjustment trimmer
Fx axis	-3 000 μ st \sim 3 000 μ st	-300 μ st \sim 300 μ st
Fy axis	-3 000 μ st \sim 3 000 μ st	-300 μ st \sim 300 μ st
Fz axis	-3 000 μ st \sim 3 000 μ st	-300 μ st \sim 300 μ st

4-2. Range of GAIN adjustment

Sensitivity can be variable with the GAIN coarse adjustment SW and the GAIN fine adjustment trimmer.

Axis	Variable ranges with GAIN fine adjustment trimmer	Sensitivity
Fx axis	$\pm 300 \mu$ ST to $\pm 5 000 \mu$ ST	Approx. 325 times to approx. 650 times
Fy axis	$\pm 300 \mu$ ST to $\pm 5 000 \mu$ ST	Approx. 325 times to approx. 650 times
Fz axis	$\pm 300 \mu$ ST to $\pm 2 000 \mu$ ST	Approx. 3 450 times to approx. 6 900 times

Above variable ranges are input converted values to obtain output of DC5V.

4-3. CALIB value

Equivalent voltage to the set CALIB value (input conversion value) can be output from each axis at the same time.

Axis	Input conversion value to output.
Fx axis	3 000 μ st \pm 15 μ st
Fy axis	3 000 μ st \pm 15 μ st
Fz axis	300 μ st \pm 1.5 μ st

4-4. Response frequency

Response frequency is set as follows:

Response frequency	Attenuation factor
100 Hz	-12 dB/oct Butterworth filter type

4-5. Bridge power supply voltage

The bridge power supply voltage shall be set as follows:

Bridge power voltage	Specifications
5 V	5 V \pm 0.15 V

5. Trouble-shooting

When abnormal point(s) is/are found during the operation of the instrument, check by the following procedures. However, when you can't find applicable item nor solve the symptom of trouble even after you have taken some measures, contact Minebea.

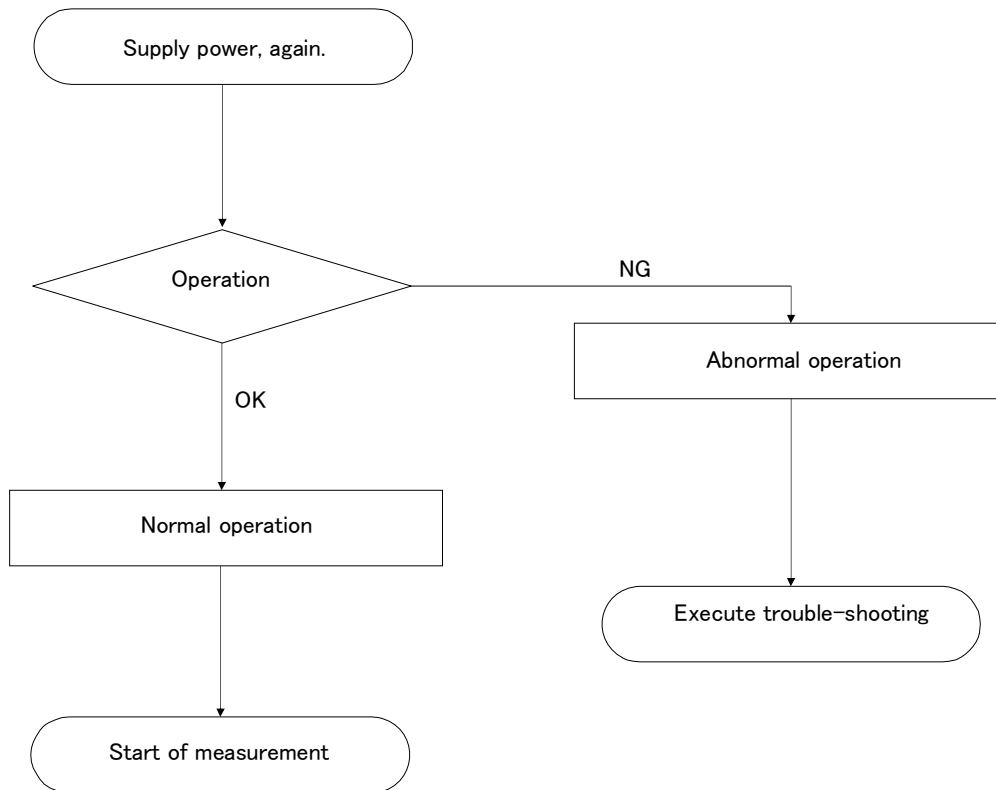

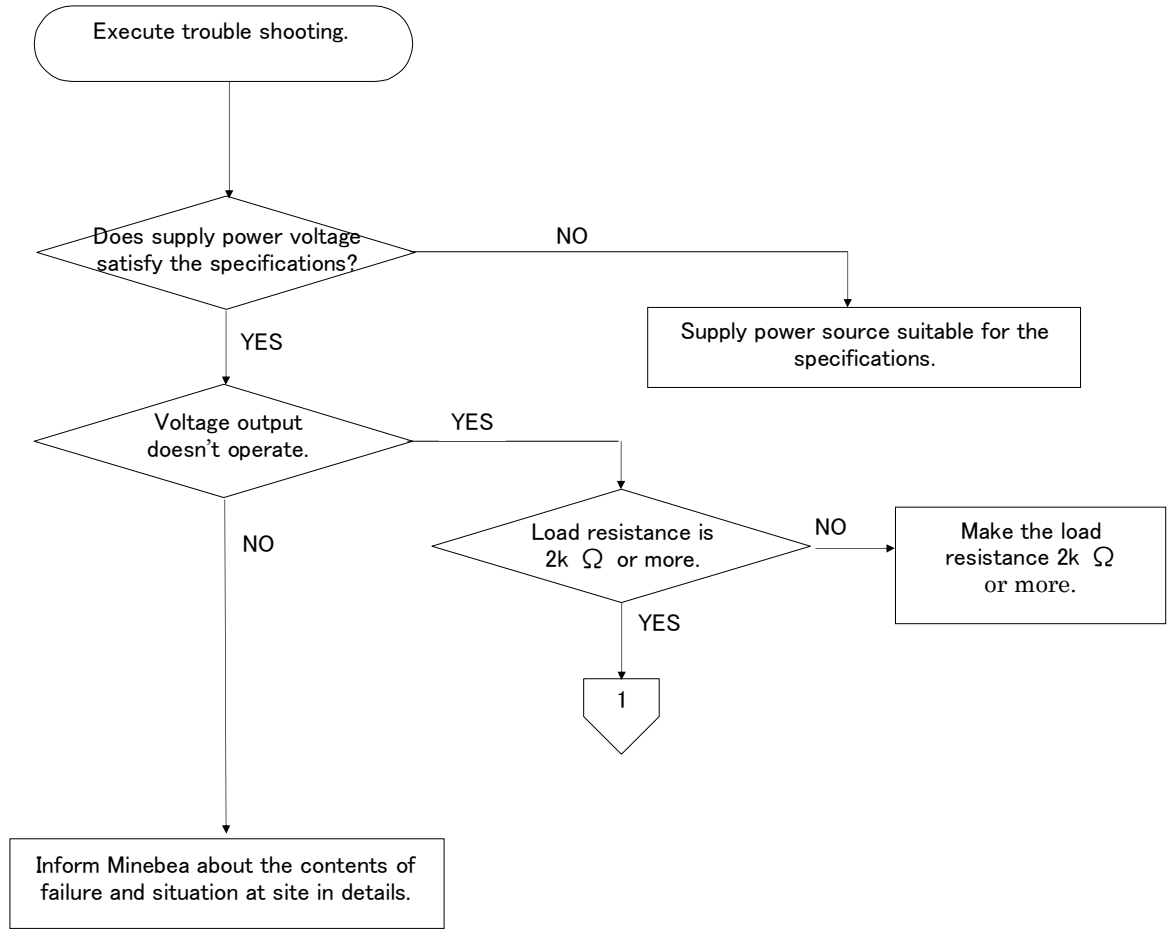

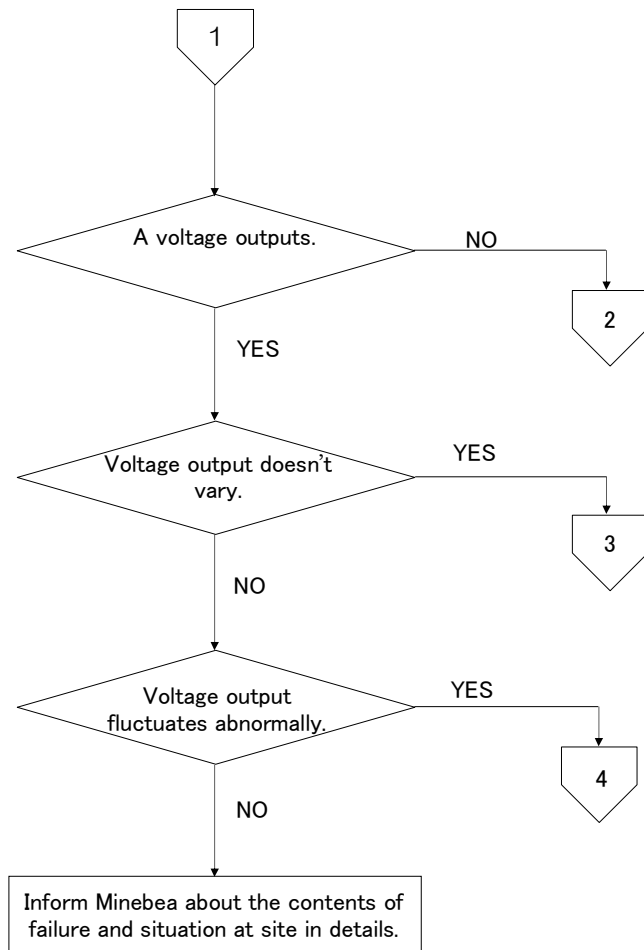

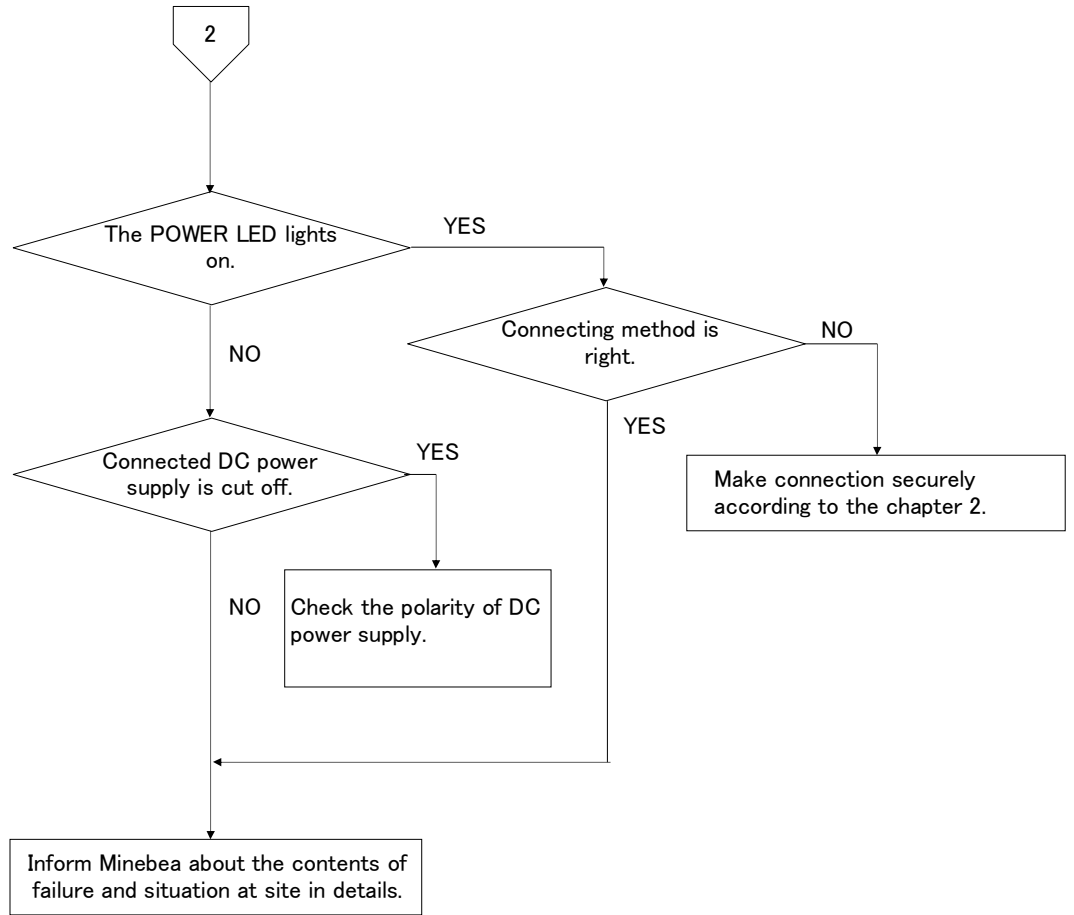

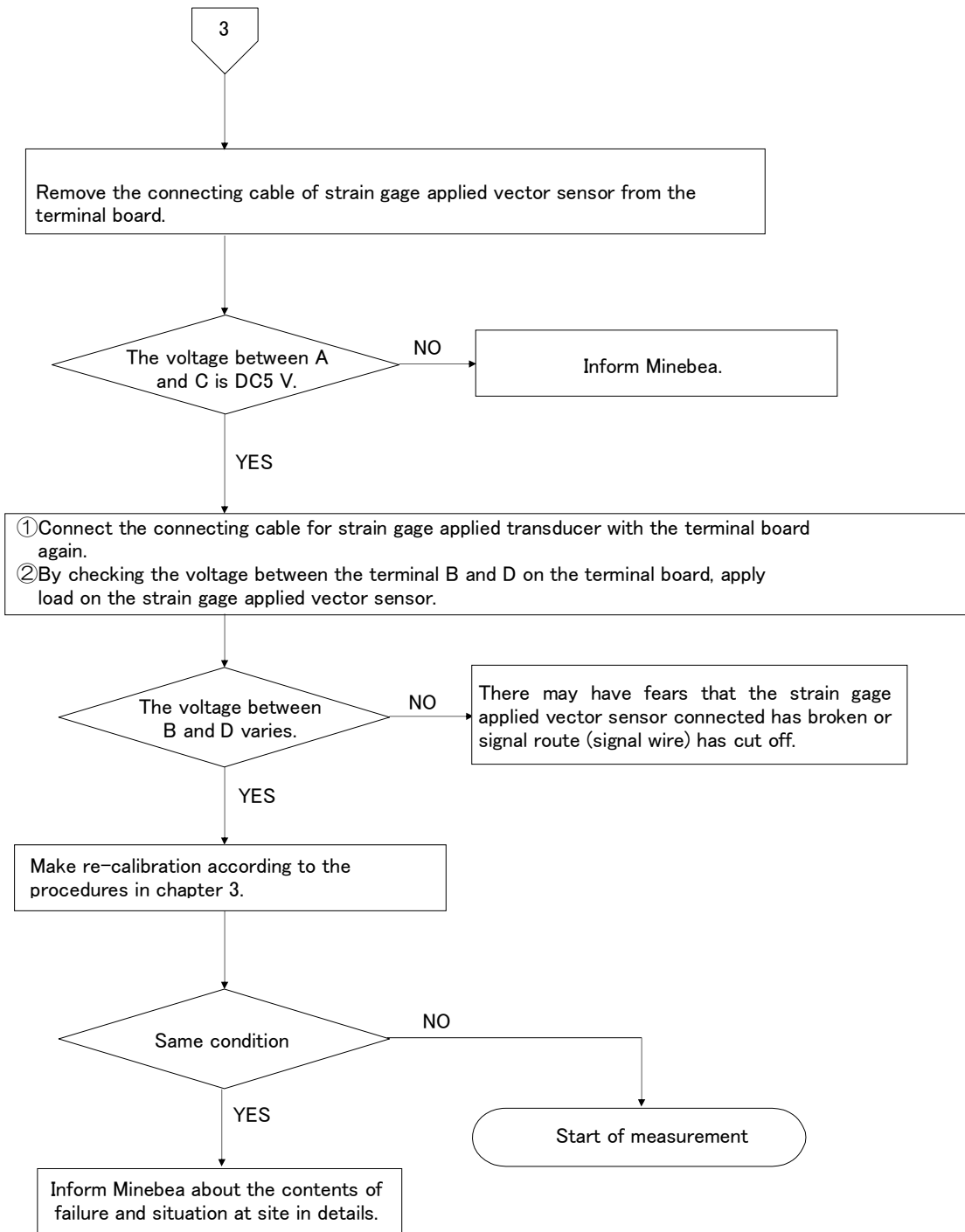

- At the time of checking the voltage between A and C, set the connecting range to DC · V on the measuring instrument such as a tester, or the like.
- At the time of checking the voltage between B and D, set the connecting range to DC · mV on the measuring instrument such as a tester, or the like.

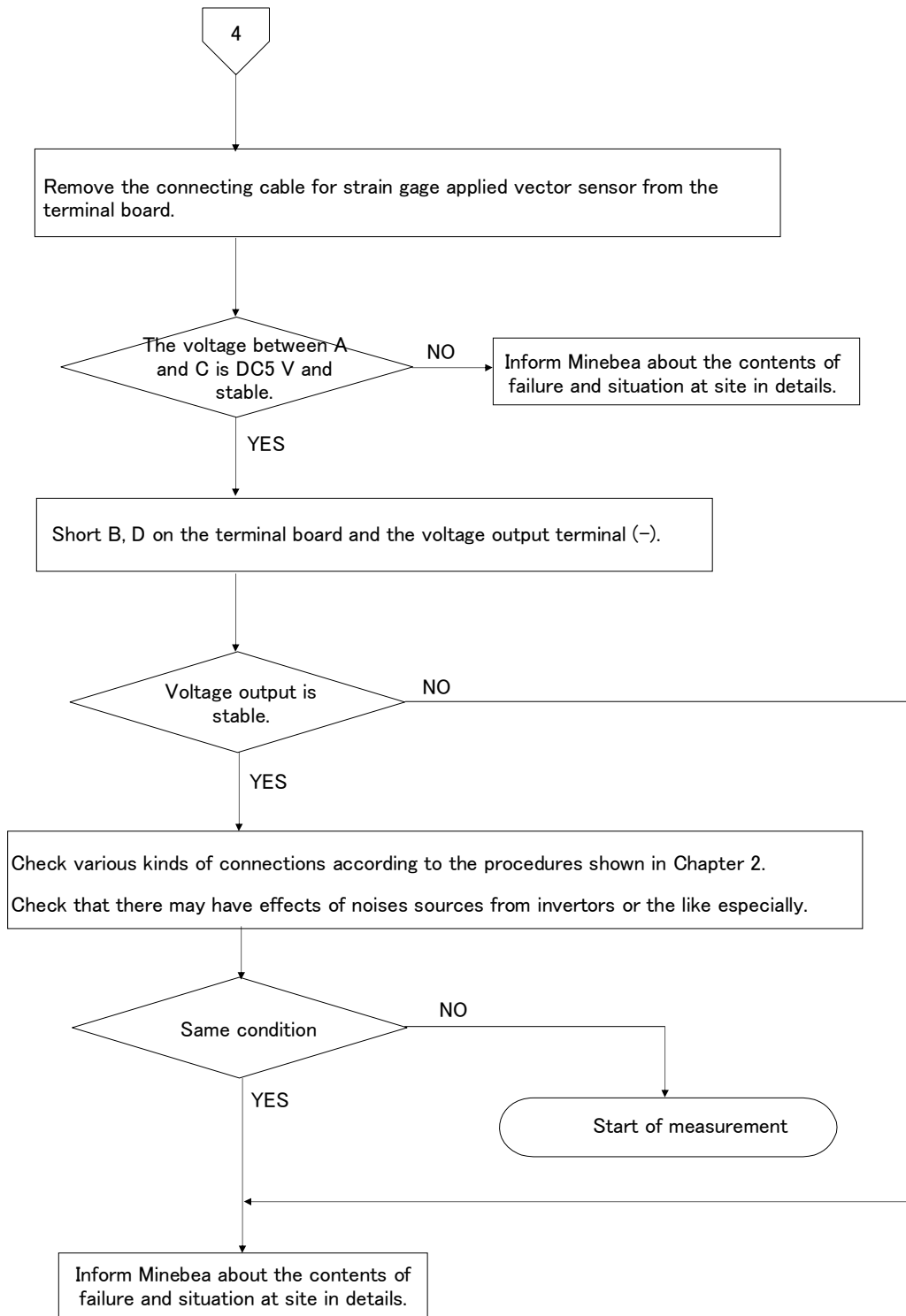

- At the time of checking the voltage between A and C, set the connecting range to DC · V on the measuring instrument such as a tester, or the like.
- At the time of checking the voltage between B and D, set the connecting range to DC · mV on the measuring instrument such as a tester, or the like.

6. Specifications

6-1. Specifications

Bridge power supply	Within DC5 V \pm 0.15 V 100 mA	
Applicable transducer	Strain gage applied type vector sensor	
Input range	Fx axis : \pm 300 μ ST to \pm 5 000 μ ST Fy axis : \pm 300 μ ST to \pm 5 000 μ ST Fz axis : \pm 300 μ ST to \pm 2 000 μ ST	
Output	DC \pm 5 V	
Output load resistance	2 k Ω or more	
Sensitivity adjustment range	Fx axis : Adjust from 1/1 to 1/2 for 650 times. Fy axis : Adjust from 1/1 to 1/2 for 650 times. Fz axis : Adjust from 1/1 to 1/2 for 6 900 times.	
Zero point adjustment range	Fx axis : Approx. -3 300 μ st to approx. 3 300 μ ST Fy axis : Approx. -3 300 μ st to approx. 3 300 μ ST Fz axis : Approx. -3 300 μ st to approx. 3 300 μ ST	
Non-linearity	0.05 %F.S.	
Effect due to temperature (voltage)	Zero point	\pm 1 μ V/ $^{\circ}$ C(Input conversion)
	Sensitivity	\pm 0.01 %F.S./ $^{\circ}$ C
CALIB	Fx axis : 3 000 μ st \pm 15 μ st Fy axis : 3 000 μ st \pm 15 μ st Fz axis : 300 μ st \pm 1.5 μ st	
Response frequency	100 Hz (-12 dB/oct) Butterworth filter type	

6-2. General specifications

Operating temperature range	Temperature	-10 $^{\circ}$ C to 50 $^{\circ}$ C
	Humidity	Less than 85 %RH (Non-condensing.)
Power source	Power supply voltage	DC24 V (Allowable variable range DC18V to DC36 V)
	Current consumption	Approx. 110 mA
Insulation resistance	Power supply line and voltage output line	DC500 V 1 minute 50 M Ω or more
Outline dimensions (W×H×D)	140 mm ×75 mm ×15 mm (Excludes protruding parts.)	
Weight	Approx. 100 g	

6-3. Accessories

Instruction manual	1 piece of book
Minus driver	1 piece

6-4. Specifications for standard shipment

Bridge power supply	DC5 V
Voltage output	Output of DC3.75 V with the input of CALIB value at each axis.
Frequency response range	100 Hz (-12 dB/oct) Butterworth filter type

7. Warranty

7-1. Warranty

- The instrument is covered by a warranty for a period of one year from the date of delivery.
- As for repairs and/or after service is required during the period of warranty, contact Minebea's sales office or sales agent from which you have purchased.

7-2. Repair

Before asking repairs, make checks once again that the connection, setting and adjustment for the instrument have finished properly or not.

Especially, make checks whether the connections of sensors are disconnected, cut off or not.

After that, still there may be found some defects in the instrument, contact Minebea's sales office or sales agency from which you have purchased.